

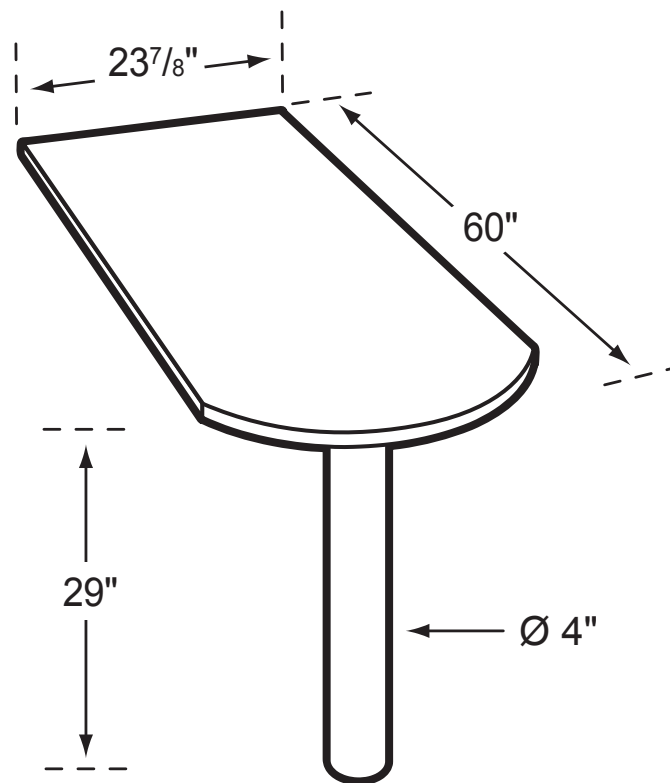

MPN24

Leg-Under Peninsula



Product Specs

- 1" thermal fused laminate top
- Matched edge banding
- 4" - 16 gage support leg
- 10 gage connecting plates
- Adjustable leveling glides