

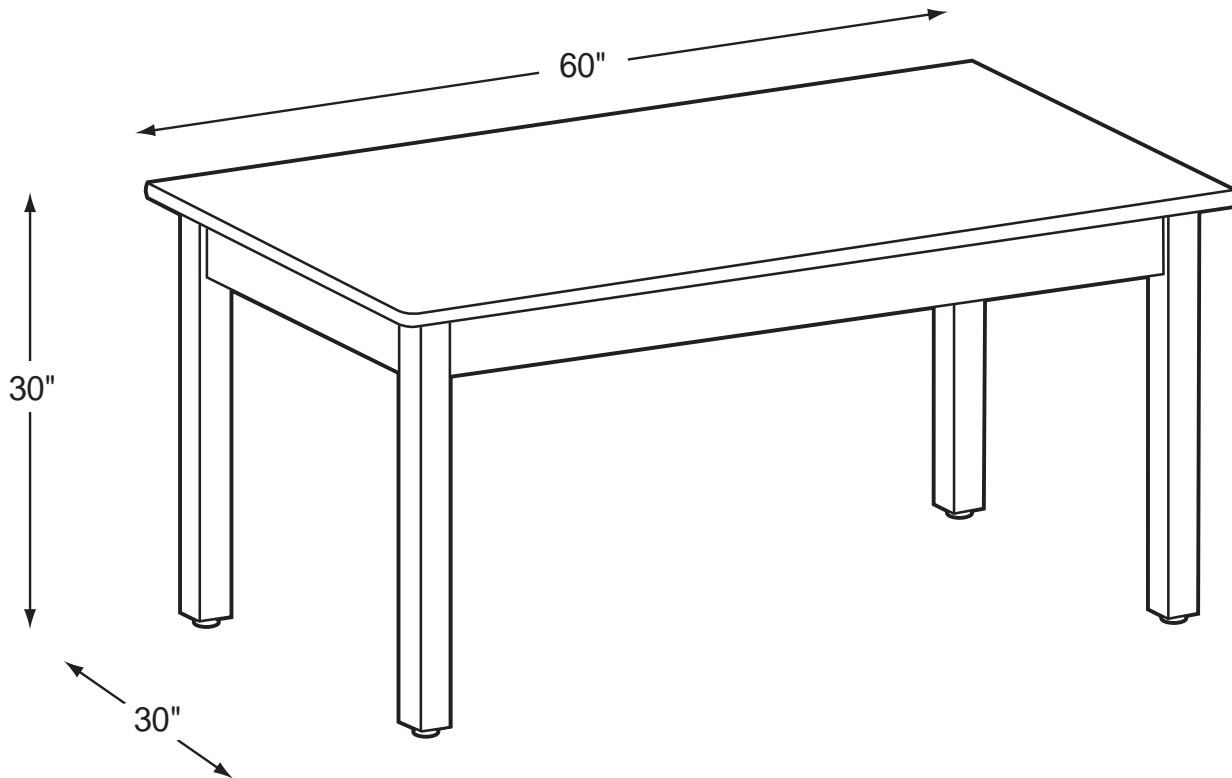

# 3060-OF

## Oak Frame Table



### Product Specs

- Select northern red oak
- 3/4" x 4" on perimeter skirts
- 180 deg. round over on exposed bottom edge
- 2-1/4 x 2-1/4" solid one piece legs
- 1/4" eased edge on exposed edges
- 2 coats of pre-catalyzed lacquer hand rubbed between coats
- 14 ga. stamped corner brackets
- 5-1/6 factory installed machine/lag screw w/ self locking nut
- 1/4-20 threaded inserts on each leg
- 1-1/8" case hardened rubber cushion glides
- #7-1-1/2" auger point, steep pitched top attachment screws